

e600

Automatic Transport Ventilator

User Manual

Table of Contents

Chapter 1	Safety.....	1
Chapter 2	Intended Use.....	4
Chapter 3	Overview	5
3.1	Control and Display Layout	5
3.2	Function Keys	6
3.2.1	ON/OFF.....	6
3.2.2	Control Selection Knob.....	6
3.2.3	Lock.....	6
3.2.4	Alarm Silence.....	7
3.2.5	Waveform	7
3.2.6	Screen Brightness	7
3.2.7	Cancel	7
3.2.8	Pause/Resume.....	7
3.2.9	Manual / Inspiratory Hold	8
3.3	External Connectors	9
3.4	Patient circuit	9
3.5	Display	10
3.5.1	Screen Layout	10
3.5.2	Live Monitoring Parameters	12
3.6	Symbols & Notations	13
Chapter 4	Preparation For Use	14
4.1	Set up	14
4.1.1	Connecting electrical power supply	14
4.1.2	Installing / replacing the battery	14
4.1.3	Connecting the gas supply	15
4.1.4	Connecting patient circuit	16
4.1.5	Turning Ventilator ON	16
4.2	Pre-use check	16
Chapter 5	Operating Instructions	19
5.1	Startup & setting the ventilation parameters	19
5.2	Ventilation modes.....	22
5.2.1	A/C V (Assist Control Ventilation)	22
5.2.2	SIMV (Synchronized Intermittent Mandatory Ventilation)	24
5.2.3	CPAP (Continuous Positive Airway Pressure).....	26
5.2.4	CPR mode	28
5.3	Turning Ventilator OFF	31

Chapter 6	Post use	32
	6.1 Disconnect device after use	32
	6.2 Storage	32
Chapter 7	Alarms and Indicators	33
	7.1 Ventilation Alarms	33
	7.2 Battery status indicator	35
	7.3 LEDs	36
Chapter 8	Cleaning, Preventive Maintenance & Servicing	37
	8.1 Cleaning & Disinfection	37
	8.2 Charging the Battery	37
	8.3 Ambient Air entrainment Filter	38
	8.4 Servicing	38
Chapter 9	Technical Data	40
	9.1 Specifications	40
	9.2 Circuit Description	42
	9.3 Battery and Power Supply	43
	9.4 Battery Operating time	44
	9.5 Electromagnetic Compatibility	44
	9.6 Oxygen consumption	46
	9.7 Oxygen Concentration delivered against different back pressures	46
Chapter 10	Trouble Shooting	47
Chapter 11	Abbreviations and Acronyms.....	48
Chapter 12	Accessories	49
Chapter 13	Warranty	50

Chapter 1 Safety

Warnings

- Federal Law restricts this device to sale by or on the order of a physician.
- The ventilator shall only be used for purposes specified under “Intended Use”.
- The ventilator should only be used by qualified personnel trained in its use.
- Strict adherence to all instructions contained within this manual is essential for safe use.
- During use, the patient must be constantly monitored by qualified personnel.
- Alternate means of ventilation must be available in case of power failure or malfunction.
- Keep away from open flames, sparks and grease/oil. To avoid the risk of fire or explosion this ventilator must not be used with flammable gases or anaesthetic agents. Operating the unit in a confined space will elevate oxygen levels.
- The ventilation setting will be interrupted during battery replacement while the device is in operational mode and the external power supply is not connected.
- Only use O-Two specified hoses, patient circuits and external power supplies to avoid affecting the output performance of the ventilator. Antistatic or conductive hoses or tubing are not used in the Ventilator Breathing System.
- Unauthorized modification of this medical device is prohibited. Do not disassemble or modify any part of the ventilator except where described in this manual. Any unauthorized disassembly will void the warranty.
- Do not use this ventilator in toxic environments as entrainment of ambient room air during spontaneous breathing or air mix mode may permit toxic gases to be delivered to the patient.
- Do not use this ventilator within a Magnetic Resonance Imaging (MRI, NMR, NMI) suite.
- Do not use this ventilator in hyperbaric (high pressure) chambers.

- Do not use the external electrical power supply outdoors as moisture may affect its function.
- Do not contact the connector from the power supply and the patient simultaneously.
- The performance of this ventilator may be affected if used around portable and mobile RF telecommunication devices (cell phones) within the minimum distance specified in section 9.5 of this user manual.
- Intake port on the patient valve must be left unobstructed for proper function & safety.
- When using a bacterial filter or HME (Heat Moisture Exchanger) connect the bacterial filter or HME to the patient connection between the elbow and the endotracheal tube or face mask, note that this action will increase the dead space. Bacterial filters or HME may increase breathing resistances.
- Use pressure regulators maintaining a minimum output flow of 120 L/min at a dynamic pressure of 45 PSI to ensure the proper functioning of the ventilator.
- Operation of this ventilator outside the environmental condition range specified in this manual may result in reduction and or failure in the ventilator's performance. In extreme temperature conditions the effect is not noticeable in terms of delivered ventilations but may cause excessive wear in ventilator or components over time. Extreme low temperature reduces operation time of the battery (Refer to 9.4 battery operating Time).
- Operation of this ventilator outside the supply pressures range detailed in this manual may result in reduction in the ventilator's performance, component failure, low pressure alarm or possible loss of automatic cycling.
- Operation of this ventilator outside the electrical power range detailed in this manual may result in reduction or failure in the ventilator's performance. Component failure, inadequate power of internal components may occur.
- Operation of this ventilator below sea level or above 4,000 m (13,000 feet) may result in reduction or failure in the ventilator's performance, low pressure alarm or possible loss of automatic cycling.
- The ventilator is intended for use in the prehospital, intrahospital, interhospital ground transport environments only.
- Connecting the patient circuit to a patient prior to turning on the ventilator may cause a calibration error.

Cautions

- When the ventilator is not in use, always turn off the gas supply.
- Never allow oil or grease to come into contact with any part of the cylinder, regulator, or ventilator.
- After use, always ensure that all components are cleaned in accordance with the instructions provided in this manual. (See section 8.1 - Cleaning and Disinfection).
- The use of this device in a carrying case may result in an increase in oxygen concentration or lower than intended ventilation volume when used in the 60 % air mix mode. When air mix mode is being used it is recommended that the ventilator be placed in its normal operating orientation and the air intake on the side of the ventilator is not obstructed.
- Never operate the ventilator without an intake filter being fitted, otherwise particles may contaminate the ventilator and affect its function.
- This ventilator must only be serviced by the manufacturer or its authorized service centers.
- Device, single use patient circuits and battery packs should be safely discarded in accordance with local state and institutional laws and procedures. .
- Spare O-Two patient circuits are recommended at all times.
- The design of this Ventilator does not incorporate a negative pressure phase during either automatic or manual ventilation.
- The external power supply and battery are component parts of the medical electrical equipment system.
- The ventilator is considered as a high flow device as its maximum flow output at pressure of 40.6 PSI is around 75 L/min. It should only be connected to a pipeline system that allows for the indicated high flow to avoid interfering with the operation of adjacent equipment.
- Always ensure that all components are assembled correctly and ready for use.
- Exhaled volume of the patient can differ from the measured exhaled volume due to leaks around the mask.
- When selecting very small tidal volumes during ventilation of infants with, take into consideration the dead space in the patient circuit.

Chapter 2 Intended Use

The e600 is a time-cycled and volume-constant emergency and transport ventilator designed for use in the pre-hospital, intra-hospital, inter-hospital and transport settings. It is intended for use with adult, child, infant patients with a tidal volume from 50 ml upwards who are in respiratory and/or cardiac arrest or respiratory distress and who require the ventilatory support.

Chapter 3 Overview

3.1 Control and Display Layout

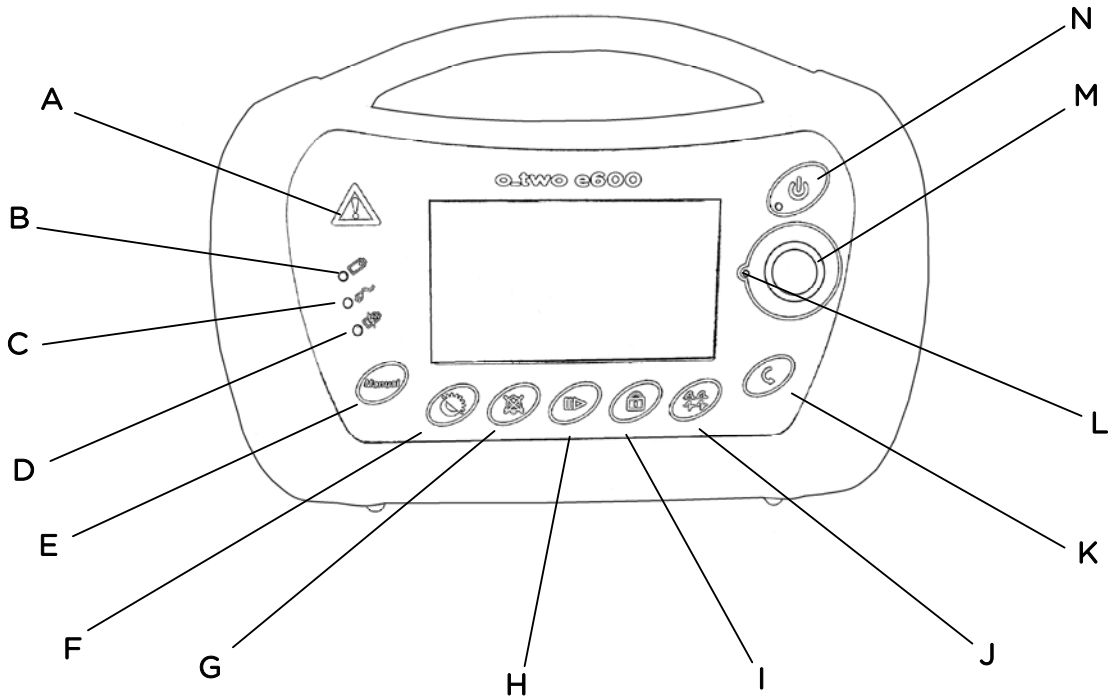

Figure 1

A - Warning indicator	H - Pause/Resume button
B - Battery operation indicator	I - Lock button
C - External power indicator	J - Waveform selection button
D - Battery charging indicator	K - Cancel button
E - Manual / Hold button	L - Confirmation indicator light
F - Screen brightness button	M - Control Selection Knob
G - Alarm Silence button	N - ON/OFF button

3.2 Function Keys

While all ventilation parameter settings are controlled by the Control Selection Knob (M) in Figure 1, there are a number of key membrane buttons which control additional ventilator functions:

3.2.1 ON/OFF

To turn on the ventilator, Press the ON/OFF button (N) in Figure 1 for one second, during that second the associated green LED will start flashing at a high frequency. After 1 second the ventilator will turn on but without ventilation until the appropriate patient size symbol is selected. If the button is pressed and released for less than a second, the ventilator will remain OFF.

To turn off the ventilator, Press and hold the ON/OFF button for 4 seconds, the green power LED will start flashing at a high frequency. After 4 seconds the ventilator will turn off and all ventilation will stop. If the button is pressed and held for less than 4 seconds, the ventilator will stay ON.



Warning

At approximately 2% of full battery capacity, the ventilator will not start when in the off position or will shut down when operating.

3.2.2 Control Selection Knob

The Control Selection Knob (M) in Figure 1 is used to navigate between parameters, change modes, select primary function change when rotated, and to confirm function changes when pressed. Diagram below illustrates path of cursor when Control Selection Knob is rotated clockwise.

Key Membrane Controls

3.2.3 Lock

Lock function will disable all buttons and the Control Selection Knob except for the ON/OFF, Alarm Silence and Day/Night buttons, which are enabled at all times.

To lock the key membrane or cancel the lock function:

- 1- Press Lock button (I) in Figure 1. The Lock symbol will be displayed on the screen.
- 2- To cancel the Lock function, press the Lock button (I) again.

Note

During lock function, if any locked button is pressed, the Lock symbol will flash while the locked button is pressed.

3.2.4 Alarm Silence

Alarm Silence button (G) in Figure 1 will silence audible alarms for 120 seconds. It can also be selected when there is no alarm in order to silence potential alarms. This function is activated or deactivated by pressing the Alarm Silence button once.

When selected, Alarm Silence symbol will be displayed on the screen.

3.2.5 Waveform

Pressing Waveform selection button (J) in figure 1 will switch between the pressure and volume ventilation waveforms displayed on the screen.

3.2.6 Screen brightness

Pressing this button will switch between 4 different screens as follows:

- 1- Light background with dark color text and waveform at 100 % light intensity.
- 2- Light background with dark color text and waveform at 35 % light intensity.
- 3- Dark background with light color text and waveform at 100 % light intensity.
- 4- Dark background with light color text and waveform at 35 % light intensity.

Note: this feature is active in ventilation mode screens only.

3.2.7 Cancel

The Cancel button (K) in Figure 1 allows the operator to return to the previous settings if the last unconfirmed changes in settings are not required.

3.2.8 Pause / Resume

During activation of the Pause/ Resume button (H) in Figure 1, the ventilator will stop ventilating with all buttons kept active (if they are not locked) except Manual/ Hold button.

To activate pause function, proceed as follows:

1. Press Pause/ Resume button (H). The Pause symbol will flash on the screen with the confirmation symbol  and the Confirmation indicator (L) to guide users to activate pause function by pressing the Control Selection Knob (M).
2. The symbol will be flashing for 10 seconds and then disappear if the Control Selection Knob (M) is not selected. Users can also press the Cancel button (K) to quit this selection before 10 seconds.
3. Once activated, a flashing yellow pause symbol will be displayed on the screen and ventilator will stop ventilating.

Note

- a. During Pause, there will be an audible alarm associated with the flashing yellow Warning indicator (A) in Figure 1 every 15 seconds. Users can press Alarm Silence button to disable the audible alarm for 2 minutes but the yellow Warning indicator will continue flashing every 15 seconds.
 - b. During Pause, users can change and confirm new ventilation settings but no ventilation will occur unless Pause function is disabled.
4. To cancel Pause function, press Pause/ Resume button (H) again. The “Resume” symbol will flash on the screen with the confirmation symbol  and the Confirmation indicator (L) to guide users to resume ventilation by pressing the Control Selection Knob (M).
 5. When ventilation is resumed, the ventilator will recommence ventilation with current settings shown on the screen unless new set-up selections were made.

3.2.9 Manual/ Hold

During exhalation phase, if Manual/ Hold button (E) in Figure 1 is pressed, a mandatory breath will be initiated and either the flow rate or set pressure control parameter will be delivered as long as the Manual/ Hold button is pressed or until I-time setting is achieved.

After I-time if the button still pressed, the ventilator will switch to inspiratory hold function in which the ventilator will cut the flow but will keep the exhalation port closed in order to block exhaled gas from going to ambient resulting in the maintenance of lung pressure.

The maximum inspiratory hold time is 6 seconds. After that time, the ventilator will switch to exhalation phase by opening airway pressure to ambient.

Note

Manual/ Inspiratory Hold function exists in all modes except CPAP and CPR.

3.3 External Connectors

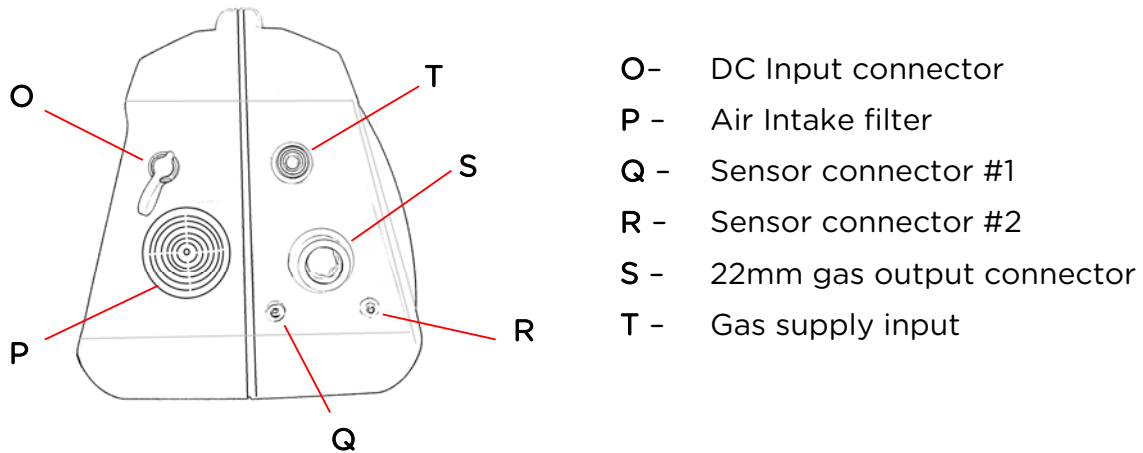

Figure 2

3.4 Patient circuit

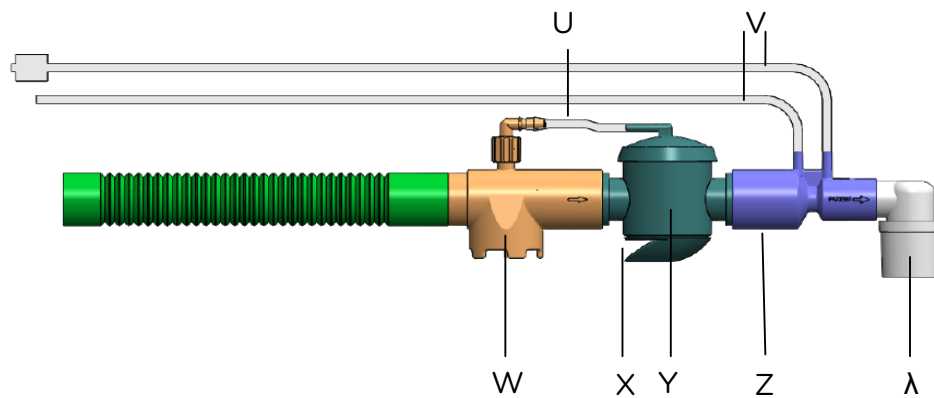

Figure 3

- U: Breathing control hose
- V: 2 pressure sensing hoses
- W: one way intake valve
- X: Exhalation port
- Y: breathing valve
- Z: Flow sensor adapter
- λ: Elbow

3.5 Display

3.5.1 Screen Layout

The screen is divided into 7 sections as shown below and each section is dedicated to display the following parameters:

- Section 1:** Battery status during charge and discharge.
- Section 2:** Live ventilation parameters (V_{te} , M_{ve} , $P_{aw_{peak}}$, $P_{aw_{AV}}$, Rate).
- Section 3:** Ventilation Modes (A/C V, SIMV, CPAP & CPR).
- Section 4:** Alarms/ Warnings.
- Section 5:** Ventilation waveforms.
- Section 6:** Set up parameters.
- Section 7:** Confirmation request/ Patient effort/ Invalid or Conflict setting.

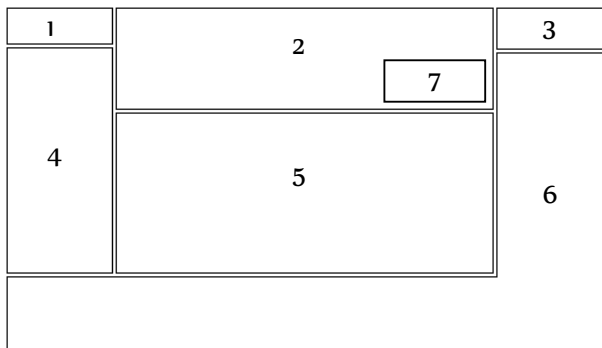

Figure 4

Note

By changing the ventilation mode, section 6 of the display will change accordingly to reflect the default or set up parameters for each mode.

The followings are screen layouts for each ventilation mode:



A/C screen layout



SIMV screen layout



CPAP screen layout



CPR screen layout

3.5.2 Live Monitoring Parameters

The following Live Monitoring Parameters are displayed at the section 2 of the screen:

Paw_{AV} (cm H₂O):

Paw AV is the average patient airway pressure measured during the last 60 seconds. This measurement is monitored by the ventilator at all times and modes. The number on the display will be updated every 15 seconds.

Mve (L):

Minute volume is the total exhaled volume for the last 60 seconds as calculated using the last 8 breaths. The Mve will constantly change as the value is recalculated and displayed at the end of exhalation phase. When unit is first turned on or resumed after pause or on selecting a new mode, the Mve calculation will be based on first then second then third and so on until the 8th exhaled tidal volume when the above logic will be followed.

Rate (BPM):

Rate (BPM) is the rate at which breaths are delivered in one minute. It is the monitored breath rate calculated by measuring the time interval (T_b in seconds) between 2 breaths. $\text{Rate (BPM)} = 60 / T_b$. The number is updated after each breath. This number will be displayed for both mandatory and spontaneous breathing phases.

Vte (ml):

Tidal volume is the volume exhaled from the patient in mandatory or spontaneous. Vte is calculated by the measurement of the entire expired flow displayed as a volume. Vte display will be updated at the beginning of the next inspiratory phase (The end of exhalation phase).

Paw_{Peak} (cm H₂O):

Peak air way pressure is the maximum pressure measured during the inspiratory phase. The displayed number on the screen represents the maximum pressure during mandatory inspiratory phase of A/CV, SIMV, CPR modes as well as spontaneous inspiratory phase of CPAP mode. This number will be updated at the end of each inspiratory phase.

Note

Mve, Rate and Paw_{AV} are not active during CPR mode and displayed with "--"

3.6 Symbols and Notations



Consult instructions for use.



Warning! Risk of injury and possible negative patient outcome.

Caution!

Warns of material damage and negative patient outcome.

Note:

Offers useful tips to assist in the proper use of the equipment.



Confirmation Symbol



Invalid Setting Symbol



Conflict Setting Symbol



Keep away from opened flames.



No smoking around ventilator.

IPX4

Ingress protection rating: Splash-proof. Do not immerse.



Class II equipment.

Protection against electric doesn't rely on Basic Insulation only, additional safety precautions such as Double or Reinforced insulation are provided.



Type BF applied part.

Chapter 4 Preparation for Use

4.1 Setup

4.1.1 Connecting electrical power supply

The e600 is designed to operate using one of the following power options:

- Internal rechargeable battery pack
- AC to DC external power supply.

Caution

- A fully charged battery must be always installed for safety reasons, even when operating from an external power supply so that continuous ventilation is not interrupted in absence of external power.
- The use of batteries other than those specified may cause the ventilator to fail and/or endanger the patient and operator.

4.1.2 Installing / replacing the battery

- 1 Make sure the ventilator is turned off and unplugged from mains electrical supply.
- 2 Turn screw knob on battery compartment cover anticlockwise to open the cover downwards.
- 3 Disconnect the battery leads and pull out the battery pack using its stand-off. Never pull the battery pack by its leads.

Caution

Always use the battery stand off to pull out the battery pack, never pull the battery by its leads (Figure 5).

- 4 Insert the fully charged battery such that the battery stand-off is positioned upwards (as per illustration below), attach battery connectors. Close cover and turn screw knob clockwise to secure.

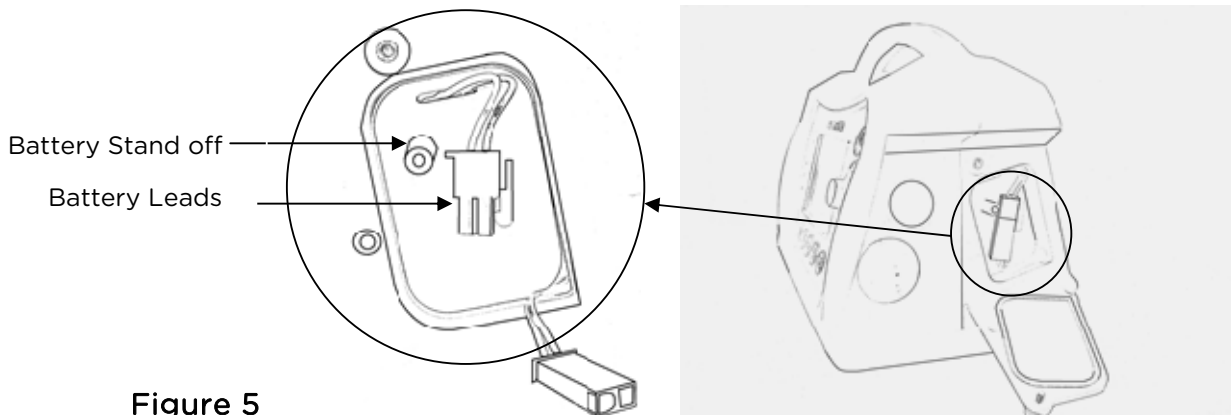

Figure 5

4.1.3 Connecting the Gas Supply

- 1 Connect the gas supply hose to the gas supply input (T) in Figure 2 of the e600.
- 2 Connect the other end of the hose to the pressure outlet of the pressure regulator or wall outlet of piped medical oxygen system.
- 3 Turn cylinder valve slowly and fully.



Warning

Extra care must be taken when handling oxygen:

- The e600 must only be used with medical oxygen.
- Only use approved medical oxygen compressed gas cylinders.
- Always begin use with a full oxygen cylinder.
- Secure oxygen cylinders so they do not fall over.
- Keep away from excessive heat to avoid the risk of explosion.
- Do not grease or lubricate oxygen fittings, cylinder valves and pressure reducers, and do not handle with greasy hands to avoid the risk of fire.
- Only open or close cylinder valves by hand or with the correct cylinder wrench. Open the valve slowly and fully. Do not use any other tools.
- Do not smoke or work in areas where open flames are present. Oxygen supports combustion and exacerbates fires.
- Only use a pressure reducer with an overpressure relief valve to limit the delivery pressure in case of a regulator failure!
- To avoid ventilator malfunction do not attach the ventilator to a flow control valve or flow meter.

4.1.4 Connecting Patient Circuit

1. Attach the O-Two patient circuit (Figure 3) to 22mm gas output connector (S) in Figure 2.
2. Connect the 2 sensor hoses (V) in Figure 3 of the patient circuit to their corresponding connectors (Q) & (R) in Figure 2.
3. DO NOT connect the patient circuit to a patient until the ventilator is turned on (Step 4.1.5) and three Solid Silhouettes start-up figures (Shown in Figure 6) are displayed.

4.1.5 Turning Ventilator ON

To turn on the ventilator, Press the ON/OFF button (N) in Figure 1 for one second. During that second the associated green LED will start blinking at a high frequency. After 1 second the ventilator will turn on but with no ventilation at this point.

If the button is pressed and released for less than a second, the ventilator will remain OFF.

Note

- Do not connect the patient circuit to a patient or the test lung before turning on the ventilator.
- A/C V with volume control (VCV) is the default start-up ventilation mode for e600.

4.2 Pre-use Check

The following check must be performed and confirmed by the Health care provider in the following cases:

- Prior to use
 - After replacing hoses, patient circuits or batteries.
 - At least every 6 months.
- 1 Visually inspect the ventilator for mechanical damage
 - 2 Ensure that battery is fully charged.
 - 3 Ensure the e600 is connected to a gas supply (Cylinder or piping system) that delivers a minimum of 45 PSI (3 Bar) and a maximum 87 PSI (6 Bar) output pressure and a minimum 120 L/min flow
 - 4 Ensure that the patient circuit and monitoring hoses have been properly connected.

5 Performance check (Leak & Function test):

To undertake the performance check, you will need the following:

- Full Oxygen cylinder.
 - Calibrated test lung (Provided with the unit).
 - Oxygen pressure regulator capable of delivering flow of 120 L/min and maintaining a minimum pressure of 45 PSI (3 Bar) and a maximum 87 PSI (6 Bar) output pressure.
- a- Connect Input hose to input connector (T) and the other side of input hose to pressure regulator outlet.
 - b- Connect power supply to DC input socket.
 - c- Connect the 2 sensor hoses of patient circuit to sensor connectors #1 (Q) and #2 (R) and connect the corrugated hose of patient circuit to output connector (S) (Refer to Figure 2).
 - d- Once the ventilator is started, connect the other end of patient circuit to test lung.

Leak Test

Once all connections are verified, slowly and fully turn on the oxygen cylinder valve. From the pressure regulator gauge reading, ensure cylinder pressure is above 650 PSI (45 bar) otherwise replace with new oxygen cylinder.

Once pressurized, turn off the oxygen cylinder and observe the pressure regulator gauge reading. If pressure does not drop more than 0.5 PSI every 30 seconds, the system is free from leaks.

To identify and repair the leak:

- 1- Release the remaining gas from the system.
- 2- Tighten all connectors firmly.
- 3- Slowly and fully turn on oxygen cylinder and repeat the above leak test procedure.
- 4- If leak still present, spray oxygen compatible leak detector on hose and connectors. Replace input hose or regulator if necessary.
- 5- Slowly and fully turn on oxygen cylinder.
- 6- Turn on ventilator and select child default setting.
- 7- Press and hold manual button (E) and observe the pressure wave form on the screen. If pressure drops immediately, inspect patient circuit connections and ensure all connectors are attached. Use leak detector if needed.
- 8- Turn off the ventilator and pressure source.

Note

If leak is still present and no external leak was detected using the above processes, the unit must be returned to the manufacturer or its authorised service center for service or repair.

Function check

After confirming no leak is present in the ventilator, with the mains electrical supply connected, proceed as follows:

- 1- Turn on the ventilator and select child default setting.
- 2- Let the ventilator cycle a few times and during cycling disconnect power supply, the back up system should switch immediately to internal battery power. LED indicators should also switch to internal battery.
- 3- Check battery level. Do not run the ventilator if battery level is low, install a fully charged battery.
- 4- During ventilator cycling, observe pressure wave and live ventilation parameters on the screen.
- 5- Disconnect the test lung and check for BCI (breathing circuit integrity) visual alarm associated with yellow warning indicator. BCI audible alarm associated with red warning indicator must activate in 15 seconds.
- 6- Block patient output completely to activate Pmax alarm should be activated.
- 7- Re-connect the test lung, BCI visual and audible alarms should be deactivated.
- 8- Change Vt and observe changes on the lung, live ventilation parameters, and the pressure wave form.
- 9- Change Rate and observe changes on the lung, live ventilation parameters and the pressure wave form.
- 10- Change I:E ratio or Ti and observe changes on the lung, live ventilation parameters and the pressure wave form.
- 11- Turn off PEEP and observe changes on the lung, live ventilation parameters and the pressure wave form.
- 12- Activate pause, night mode, and flow waveform to ensure proper functions and screen display.
- 13- Turn off oxygen cylinder and check for low pressure and no pressure audible and visual alarms.
- 14- Turn off Ventilator by pressing ON/OFF button for 4 seconds.

Chapter 5 Operating Instructions

5.1 Start Up and Setting the Ventilation Parameters

- a. Turn on the ventilator:

To turn on the ventilator, press the ON/ OFF button (N) in Figure 1 for one second. During that second the associated green LED will start blinking at a high frequency. After 1 second the ventilator will turn on but with no ventilation at this point. If the button is pressed and released for less than a second, the ventilator will remain OFF.

Note

Do not connect the patient circuit to a patient before the ventilator is turned on and three Solid Silhouettes figures (Figure 6) are displayed.

- b. Start default ventilation:

Once the ventilator is turned on, 3 Solid Silhouettes start-up figures (Shown in Figure 6) will be displayed on the screen representing Infant, Child and Adult patient sizes. Each size comes with pre-set parameters close to the patient's size to guide the user to select for instant start-up. This eliminates the need for a potentially long set up before starting ventilation.

Note

Start-up figures are used during start up only and are not active during ventilation.

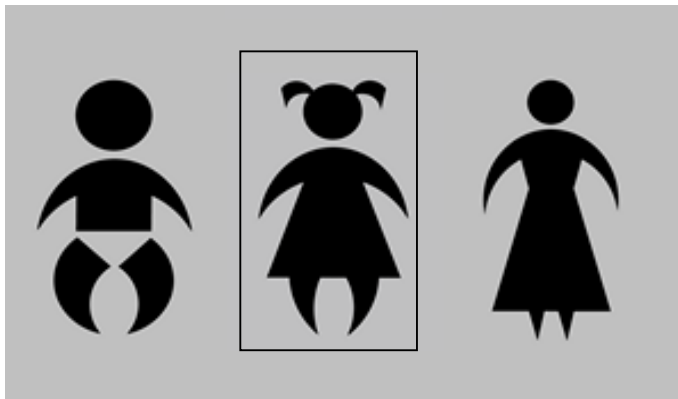

Figure 6
Start-up Figures

Healthcare providers navigate among the three start-up figures by rotating the Control Selection Knob (M) and a square cursor will move around the selected figure. Once the desired patient size is selected, the user must confirm the selection by pressing the Control Selection Knob (M) to start ventilation. If no selection occurs within 20 seconds, the ventilator will start ventilation with child setting as its default start-up.

Press the Control Selection Knob (M) to confirm the patient size selection and connect the patient valve to the patient, the ventilator starts volume controlled A/C V ventilation with default parameters listed in Table 1 depending on the selected patient size (Figure 7). User can also pause the ventilation by pressing Pause/ Resume button (H) until all desired parameters are selected.

Note

A/C V with volume control is the default start-up ventilation mode.

- c. Set up the desired ventilation setting:

Health care providers may choose or change the ventilation mode or parameter setting any time during ventilation by the following method:

Rotate the Control Selection Knob (M) and move the yellow cursor (Figure 8) to section 3 of the screen (Figure 4) for ventilation mode setup, or to the parameter to be set up located at section 6 of the screen (Figure 4). The user must confirm the selection by pressing the Control Selection Knob (M). Once confirmed, the selected area will be highlighted with solid contrast background (Figure 9).

Navigate among the available settings by rotating the Control Selection Knob (M). Press the Control Selection Knob (M) to choose the desired setting. The chosen setting will turn yellow with the flashing confirmation symbol  and the Confirmation indicator (L) to guide users to activate the setup by pressing the Control Selection Knob (M) again.

Press the Control Selection Knob (M) to activate the setup. Or repeat the above steps to continue to set up the other parameters. The operator can also press the Cancel button (K) to go back to previous parameters before activation. Finally, press the Control Selection Knob (M) to activate the multiple setting setup at once.

Note

If no selection occurs within 10 seconds or the Control Selection Knob (M) is not pressed to confirm the changed parameter setting within 10 seconds, changes will be cancelled and the previous parameter values will remain.

AC/V Settings	Infant	Child	Adult
Rate (BPM)	30	15	10
Vt (ml)	100	250	500
Mv (L) (calculated values)	3.0	3.7	5.0
PEEP (cm H ₂ O)	5	5	5
P max (cm H ₂ O)	25	25	30
P min (cm H ₂ O)	3	3	3
Ti (Sec.)	0.66	1.33	2.0
I:E	1:2	1:2	1:2
O ₂ (%)	100%	100%	100%
F trig. (L/min)	3	3	3

Table-1 A/C V mode default settings

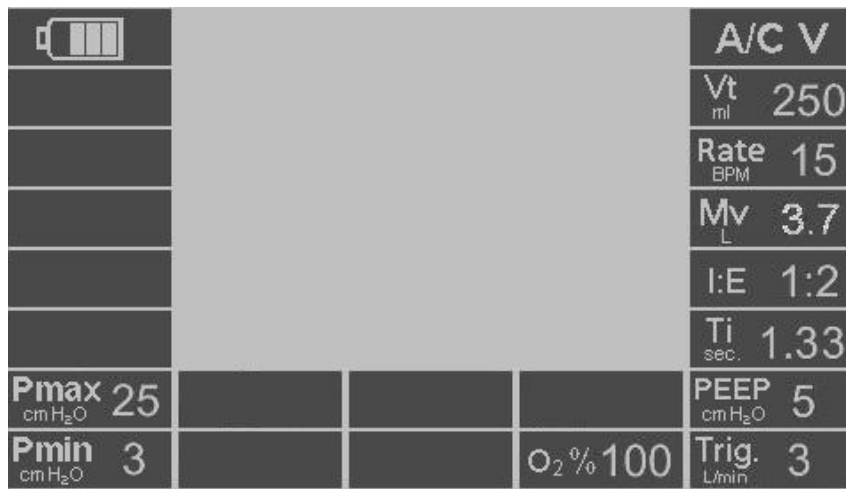
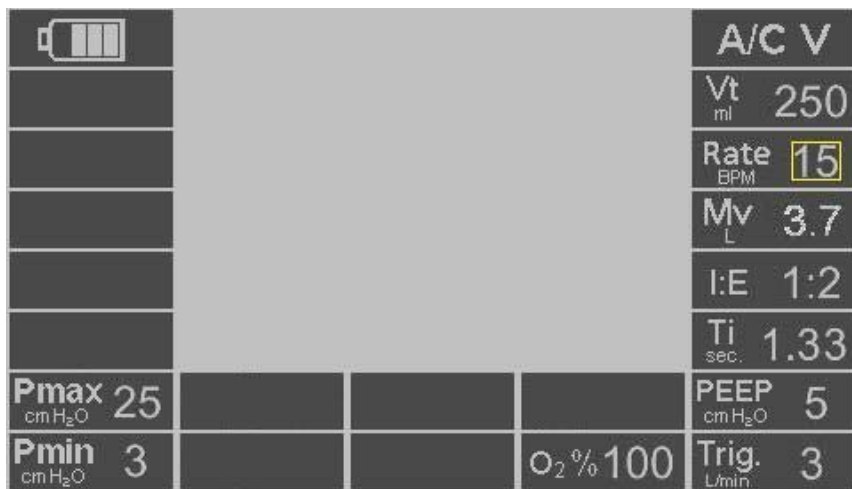

Figure-7

A/C V mode screen w/ default parameters (Child setting)



Showing frame around Parameter during selection

Figure-8

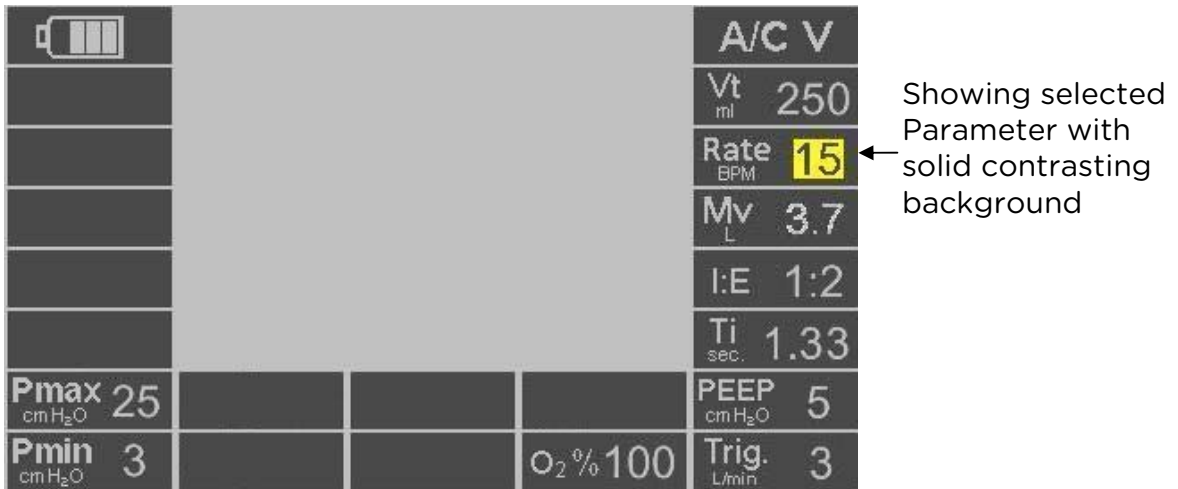

Figure-9

5.2 Ventilation Modes

The e600 ventilator is equipped with a number of ventilation modes to enable the healthcare provider to tailor the ventilator settings to the patient's specific respiratory requirements. Ventilation could be delivered invasively (ET tube) or non-invasively (mask).

In all modes, should the patient demand more flow than set by Health care provider, he/she can inhale the required volume from ambient.

Each ventilation mode has a default setting (based on the initial patient size setting selection on startup) which will be initiated on selection of that specific ventilation mode if no changes to the settings are made.

Note

When switching between ventilation modes, any shared parameter will be carried over and any new parameter will be set to the default.

5.2.1 A/C V (Assist Control Ventilation).

In AC/ mode (Figure 10) the ventilator can deliver volume ventilation (VCV) with Tidal Volume and ventilation Rate setting according to patient size (see Table-2 below).

During A/C V mode, the ventilator will deliver Controlled Mandatory Ventilation (CMV) regardless of any patient's effort if the trigger (Trig.) is disabled (displayed with (-)).

The default trigger for A/C V is 3 L/min but can be adjusted up to 15 L/min.

If no inspiratory effort is detected during the trigger window, the ventilator will initiate mandatory ventilation at the end of trigger window. Should the patient demand more flow than set by user, he/she can withdraw the excess from ambient.

Table-2 Default Ventilation Setting- A/C V

Parameter	Range	Default		
		Infant	Child	Adult
Tidal Volume	(50 - 2000 ml)	100	250	500
Rate	(5 - 60 BPM)	30	15	10
Mv	Calculated based on Vt & f	3.0	3.7	5.0
I:E ratio	(1:4 - 3:1)	1:2	1:2	1:2
Ti*	(0.2 - 9 sec.)	0.66	1.33	2.0
PEEP	(OFF, 4-20 cm H ₂ O)	5	5	5
Trig.	(OFF, 1 -15 L/min)	3	3	3
O ₂ %	(100% or 60% O ₂)	100	100	100
P max.	10 -80 cm H ₂ O	25	25	30
P min.	0-20 cm H ₂ O during I time only	3	3	3
Manual	Refer to Manual and I-Hold section	ready	ready	ready

* Ti may be limited below its range depending on set I:E ratio and rate.

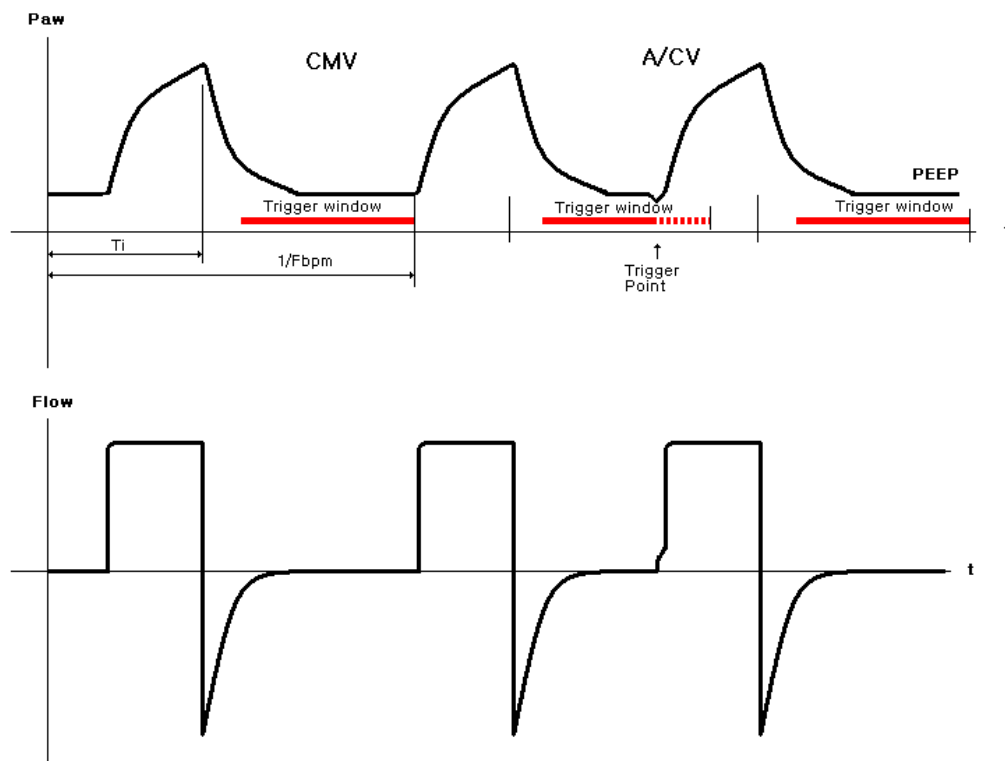

Figure-10 A/C V waveform

5.2.2 SIMV (Synchronized Intermittent Mandatory Ventilation).

In SIMV mode the ventilator will deliver volume ventilation at the set Tidal Volume (V_t) and Rate (BPM).

The default trigger for this mode is 3 L/min but can be adjusted up to 15 L/min. if trigger condition is met, the ventilator will deliver synchronized volume controlled mandatory ventilation.

In SIMV mode the selected breathing rate remains constant and the time of spontaneous breathing window will change if patient triggers the synchronized mandatory breath before the normal start of inhalation phase (beginning of T_i).

If no effort was detected during the trigger period, the ventilator will initiate mandatory ventilation at the end of trigger window (Figure 11). Should the patient demand more flow than set by user, he/she can withdraw the excess from ambient.

Table-3 Default Ventilation Setting- SIMV

Parameter	Range	Default		
		Infant	Child	Adult
Tidal Volume	(50 - 2000 ml)	100	250	500
Rate	(5 - 60 BPM)	30	15	10
Mv	Calculated based on V_t & f	3.0	3.7	5.0
I:E ratio	(1:4 - 3:1)	1:2	1:2	1:2
T_i^*	(0.2 - 9 sec)	0.66	1.33	2.0
PEEP	(OFF, 4-20 cm H ₂ O)	5	5	5
Trig.	(1 -15 L/min)	3	3	3
O ₂ %	(100% or 60%)	100	100	100
P max.	10 -80 cm H ₂ O	25	25	30
P min.	0-20 cm H ₂ O (during I time only)	3	3	3
Manual	Refer to Manual and I-Hold section	ready	ready	ready

* T_i may be limited below its range depending on set I:E ratio and rate.

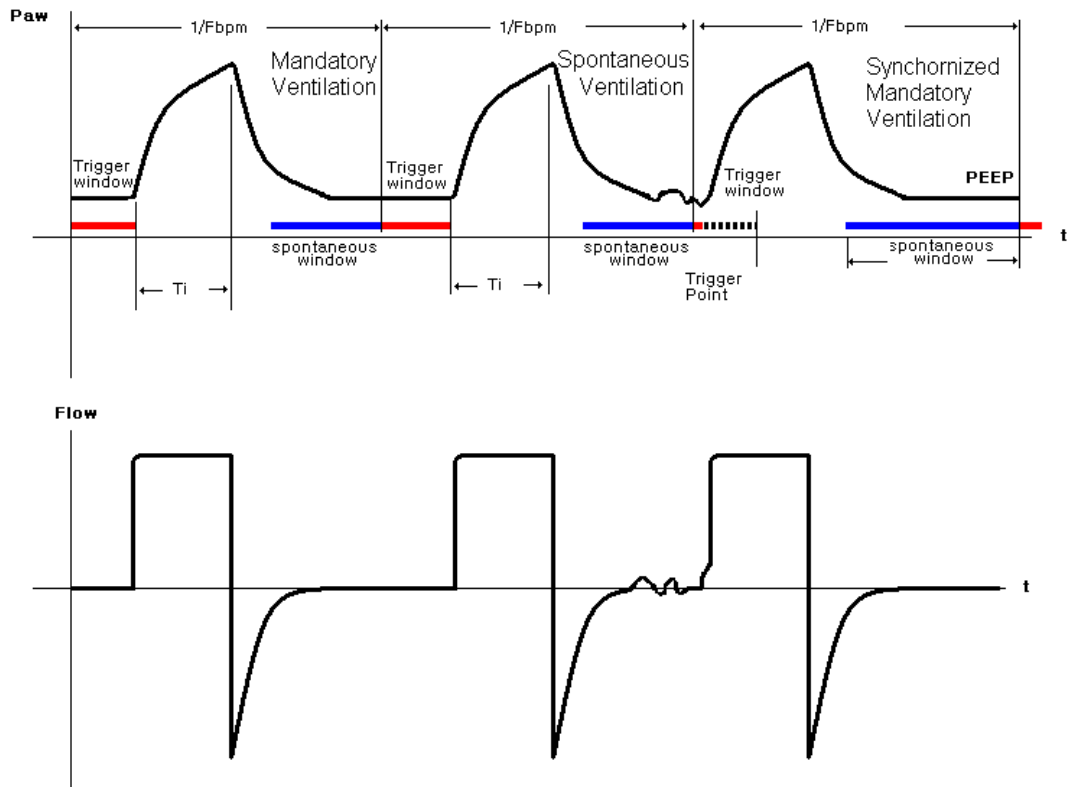

Figure-11 SIMV waveform

5.2.3. CPAP (Continuous Positive Airway Pressure)

In CPAP mode, the ventilator will deliver a continuous flow rate to generate airway pressure and use the control valve to maintain CPAP levels (Figure 12).

Note

The default trigger in CPAP mode is pressure trigger (P) which is set at 2 cm H₂O below CPAP settings.

In this option the ventilator adjusts the amount of flow internally to maintain average airway pressure close to CPAP setting.

The CPAP mode is equipped with APNEA back up ventilation in which the ventilator switches to Assist Control ventilation (A/C V) when the ventilator does not trigger patient's spontaneous breathing for a period of time (T APNEA) set by the user. The parameters of back up A/C ventilation are defaulted to volume ventilation based on the initial start up patient size selection unless changes are made by the user.

The trigger changes from pressure trigger (P) to 3 L/min default flow trigger when the ventilator switches to APNEA back up.

Table-4 Default Ventilation Setting- CPAP

Parameter	Range	Default		
		Infant	Child	Adult
CPAP	(4-20 cm H ₂ O)	5	5	5
Trig.	(P or 1 -15 L/min) P = 2 cm H ₂ O below base line	P	P	P
O ₂ %	(100% or 60%)	100%	100%	100%
T APNEA	(10-60 seconds)	20	20	20
Vt(A)	(50 - 2000 ml)	100	250	500
Rate (A)	(5 - 60 BPM)	30	15	10
Mv (A)	Will be calculated based on Vt & f	3.0	3.7	5.0
I:E ratio (A)	(1:4 - 3:1)	1:2	1:2	1:2
P max.	10 -80 cm H ₂ O	25	25	30
P min.	0-20 cm H ₂ O during I time only	3	3	3

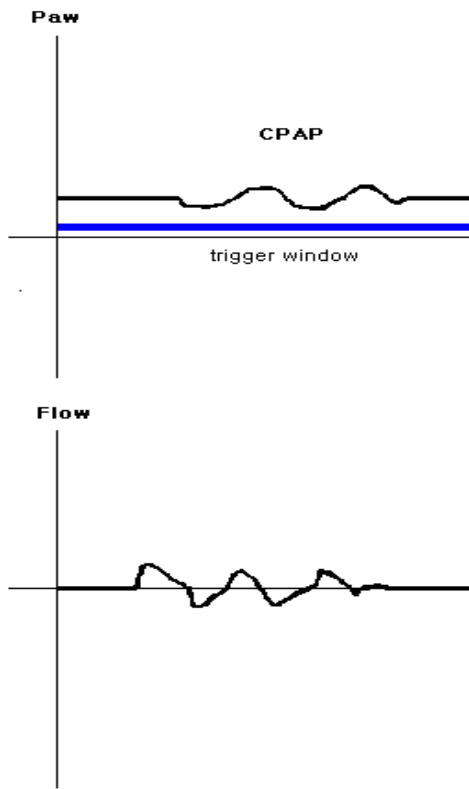

Figure-12 CPAP ventilation waveform

5.2.4 CPR mode

The CPR mode consists of timed chest compression audible prompts coupled with automatically delivered breaths for both intubated and mask ventilated patients. There is also a visual animated display to guide the health care provider while performing CPR.

The CPR mode for masked ventilated patients is the default setting for this mode but changes can be made between the 2 sub-modes at any time.

The CPR mode for masked ventilated patients consists of 2 phases, chest compression and ventilation. 30 chest compressions over 18 seconds are synchronized with audible prompts and on screen visual animations, followed by two, 1 second, mandatory breaths within a 5 second ventilation phase. The ratio between chest compressions and ventilations is 30:2 (Figure 13a).

The CPR mode for intubated patients consists of continuous compressions indicated by an audible prompt and visual animation at a rate of 100 compressions per minute plus automatically delivered breath every 6 seconds (Figure 13b).

The ventilation in CPR mode is flow controlled ventilation. The default tidal volume is set according to the initial start-up patient size selection when switching to CPR mode but could be adjusted to desired values. The FiO_2 is fixed at 100% oxygen during CRP mode.

The ventilator will automatically compensate up to 30% of the required tidal volume V_t in case a leak is detected. Beyond this limit, low P_{aw} visual and audible alarms will be activated to warn rescuer to either re-apply the mask or increase the set tidal volume.

Table-5 Default Ventilation Setting- CPR

Parameter	Range	Default		
		Infant	Child	Adult
Tidal Volume	(50 - 1400 ml)	100	250	500
P max.	(10 -80 cm H ₂ O)	40	40	60
P min.	(0-20 cm H ₂ O during I time only)	3	3	3

CPR for masked patients

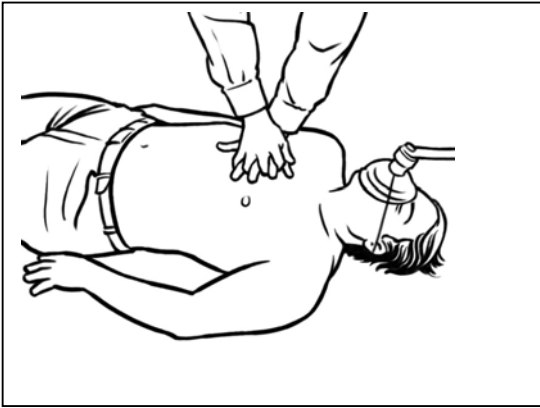

On screen chest compressing animation

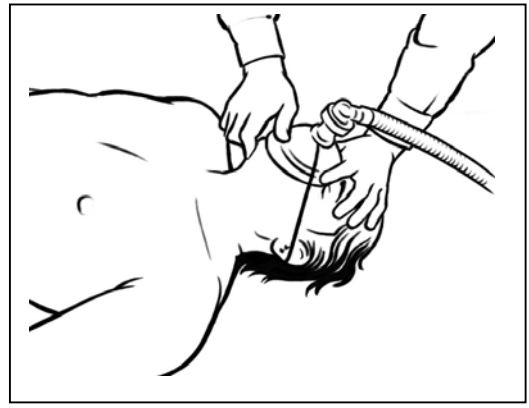

On screen ventilation animation

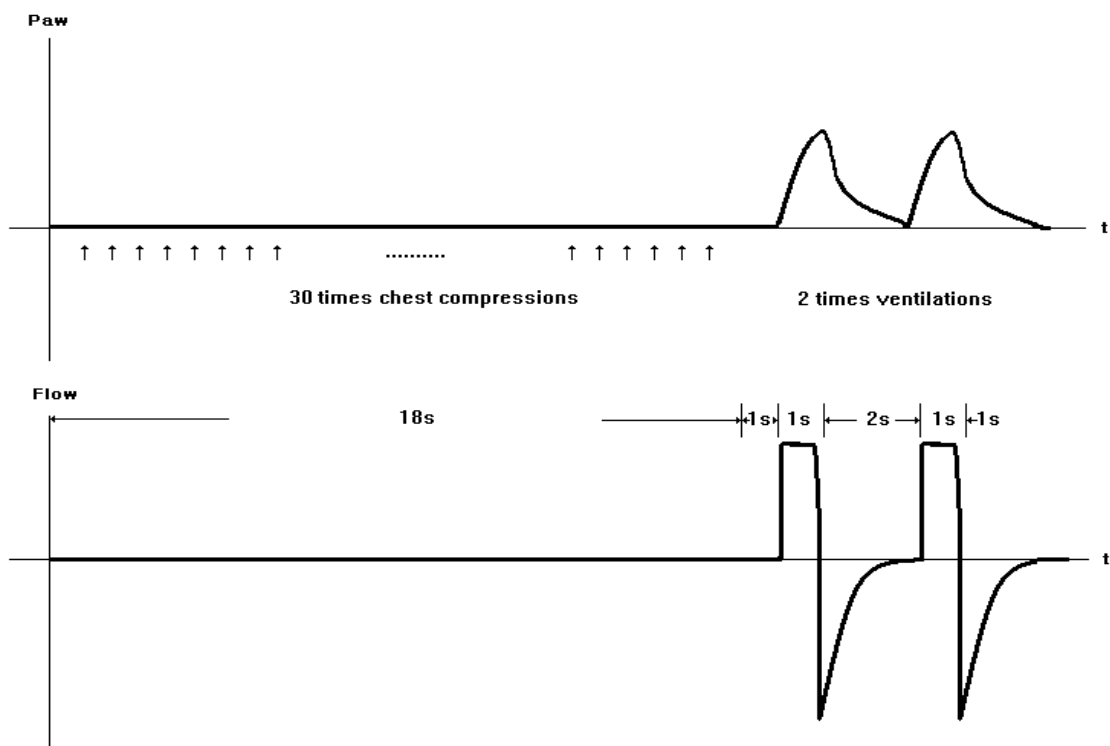
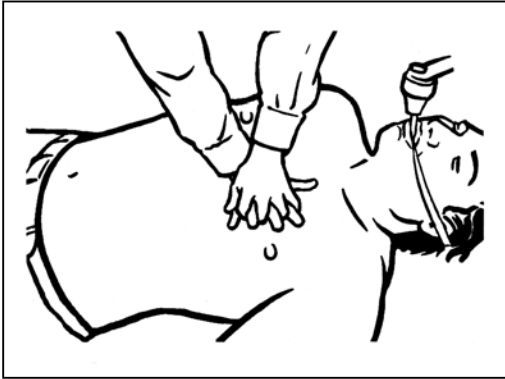

Figure-13.a CPR waveform for masked patient

CPR for intubated patients



On screen intubated CPR animation

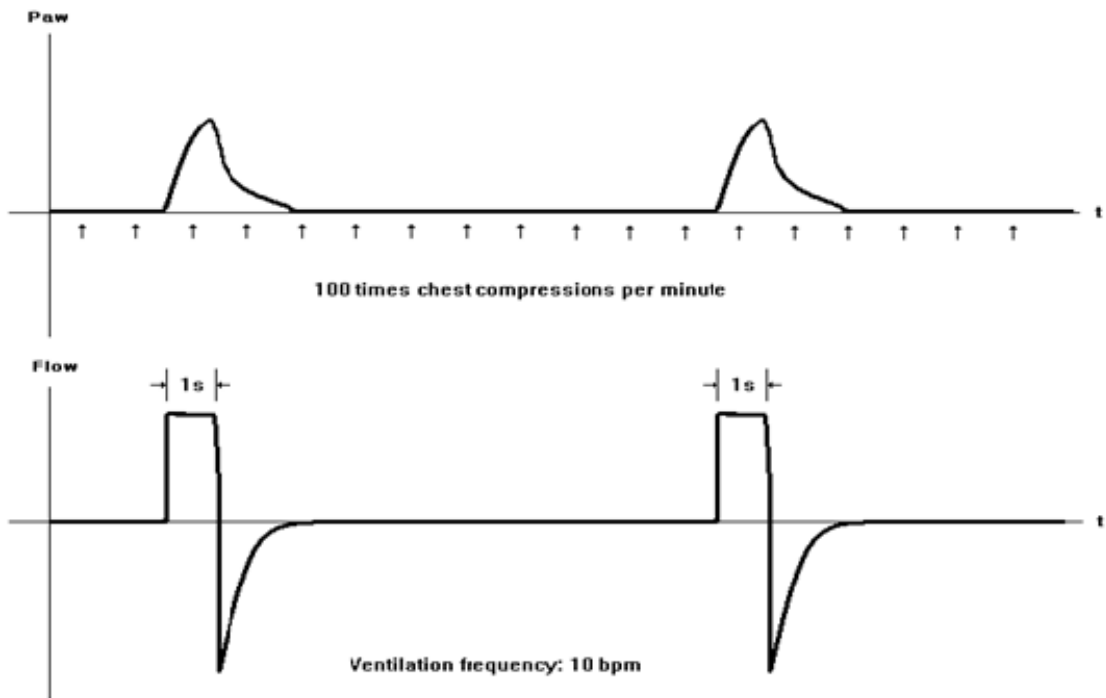

Figure-13.b CPR waveform for intubated patient

5.3 Turning the Ventilator Off

Press and hold the ON/OFF button for 4 seconds, the Ventilator will turn OFF.

Chapter 6 Post Use

6.1 Disconnect Device After Use

- a. Turn off gas supply to the ventilator.
- b. Disconnect gas supply hose.
- c. Disconnect patient circuit from the output connector.
- d. Unplug the power cable from mains if no charging is required.
- e. Clean and disinfect according to section 8.1 in this manual

6.2 Storage

Store ventilator within the following environmental range:

- 40°C to +60°C, Rh: 15% to 95%.

Chapter 7 Alarms and Indicators

7.1 Ventilation Alarms

Visual and Audible alarms continue until the cause of the alarm is resolved.

During alarm activation the user may press the Alarm Silence button (G) in Figure 1 which will silence the audible alarm for 2 minutes but the visual alarm will continue to flash until the cause of the problem is resolved.

















During “alarm silence”, should a new alarm develop, the Alarm Silence function will continue and only the new alarm will be shown flashing on the screen.

Alarms will be visible in section 4 or section 7 of the display (Figure 4).

There could be multiple alarm/warning symbols visible on the screen indicating multiple failures occurring at the same time. In this case the visible and audible alarms will be based on highest priority alarm.

All ventilation alarms of e600 are listed in the following Table-6.

Table-6 Ventilation Alarms

Symbol	Name	Priority	Visual Alarm		Audible Alarm
			Alarm symbol	Warning LED	
 BCI	Patient Circuit disconnect (Breathing circuit Integrity)	High after 15 seconds	Flashing symbol	Flashing Yellow for 15 seconds then Red	15 sec. delay Two bursts with five pulses
Low Paw	Low Airway Pressure	High	Flashing symbol	Red	Two bursts with five pulses
HighPaw	High Airway Pressure	High	Flashing symbol	Red	Two bursts with five pulses
 LEAK	Leak (at 40% below set Vt)	High	Flashing symbol	Red	Two bursts with five pulses
	No Oxygen \leq 20 PSI	High	Flashing symbol	Red	Two bursts with five pulses
	Low Oxygen \leq 40 PSI	Medium	Flashing symbol	Yellow	One burst with three pulses
	High input pressure \geq 90 PSI	High	Flashing symbol	Red	Two bursts with five pulses
 APNEA	APNEA	High	Flashing symbol	Red	Two bursts with five pulses
	Empty Battery	High	Flashing symbol	Red	Two bursts with five pulses
	Low Battery	Low	Flashing symbol	N/A	N/A
	Pause	N/A	Flashing symbol	Yellow every 15 seconds	N/A
	Play	N/A	Flashing symbol	N/A	N/A
	Lock	N/A	Solid symbol	N/A	N/A
	Alarm Silence	N/A	Solid symbol	N/A	N/A
 PATIENT EFFORT	Patient effort	Low	Solid symbol during Patient effort	N/A	N/A
	Invalid setting- Refer to manual	N/A	Solid symbol During invalid selection	N/A	N/A
	Setting Conflict	N/A	Solid symbol During invalid selection	N/A	N/A
	Confirm	N/A	Flash symbol after primary selection	N/A	N/A

7.2 Battery Status Indicator

Battery status will be displayed in section 1 of the display (Figure 4). There are two different status indicators showing battery discharging (Table-7.1) and charging (Table-7.2) status respectively.

Table-7.1 Battery discharging status









1		Full Capacity	No Alarm
2		Approx. 75% of full capacity	No Alarm
3		Approx. 50% of full capacity	No Alarm
4		Approx. 25% of full capacity	On screen symbol change to Yellow color and flashing
5		Approx. 5% of full capacity	On screen symbol change to Red color and flashing with associated Red color warning LED.

Table-7.2 Battery charging status

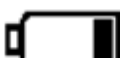
1		Full Capacity	No Alarm
2		95% of full capacity	No Alarm
3		90% of full capacity	No Alarm
4		80% of full capacity	No Alarm
5		65% of full capacity	No Alarm



Warning

At approximately 2% of full battery capacity, the ventilator will not start when it is turned off or will shut down when it is turned on.

Note

Battery capacity levels are detected from measured voltages and the capacities shown above are based on results from new batteries tested at room and low temperature. Battery capacity levels are subject to change when old batteries are used.

Fully charged Batteries must be recharged after 6 months without usage or when battery discharging LED turns orange and flashing. Battery Re-charging time is about 5.5 hours from fully discharged. Batteries have a minimum of 200 discharge and charge cycles.

7.3 LEDs



Green color LED - Continuous when unit is ON and flashing when unit is OFF.



Red or Yellow color LED - Flashing during alarm/ warning situation. LED color depends on the severity of the failure.



Green color LED - Continuous when unit is connected to AC power source during both ON and OFF phases.



Orange color LED - Continuous when unit is charging and off when battery is fully charged during both ON and OFF phases. During OFF phase this light will start flashing when battery capacity drops to around 90 %.



Green color LED - Continuous when unit is operated using internal battery.

Chapter 8 Cleaning, Maintenance & Servicing

8.1 Cleaning and Disinfection

Disinfect the ventilator housing and supply hose using a damp cloth with a commercially available, legally marketed disinfectant solution which is compatible with the materials of manufacture in accordance with local protocols. Do not use chlorine based cleaning agents. Make sure no liquids enter the ventilator connections or the ventilator.

Do not immerse the e600 Ventilator or patient circuit or supply hoses in disinfectant or other liquids, serious electric shock hazard and damage to the ventilator may occur. If the Ventilator is accidentally submerged in any liquid it must be returned to the manufacturer for factory service.

Do not attempt to clean intake filter or patient circuit. Using a wet or damp filter may result in inaccurate parameters and potentially damage the ventilator.



Risk of Explosion!

Cleaning agents containing alcohol or grease become flammable when combined with compressed oxygen and can cause explosions.

8.2 Charging the battery

1. Connect one end of the external power supply/charger to its supply (100 to 240 Volts or on-board vehicle socket) and the other end to the DC input socket (O) in Figure 2 located on the side panel of the ventilator. The indicator lights up as follows:



Green LED - Continuous when unit is connected to external power source during both ON and OFF phases.



Orange LED - Continuous when unit is charging and off when battery is fully charged during both ON and OFF phases.

2. Turn unit ON and observe battery level (section 1 of the screen), Refer to 7.2 Battery Status Indicator for exact battery charging status. The battery shall be fully charged.

Caution

The ambient temperature shall be between 0 °C and 35 °C during battery charge.

Note

- The Battery pack can be charged during operation.
- The Battery pack may be charged using external power supply supplied with the unit or the optional DC to DC power supply.
- The Battery pack should be replaced after 200 charge/discharge cycles or if the battery pack will not fully charge (as indicated on the battery display on the ventilator) or if the ventilator doesn't run for more than 5 hours on a single charge.

8.3 Ambient Air Entrainment Filter

The e600 entrains ambient air through the internal Venturi system for ventilation when the O₂ concentration is set at 60%. This provides not only decreased oxygen concentration but also increases the ventilator operating time on an oxygen cylinder.

Caution

Always keep the ambient air entrainment port clear of obstructions. Always replace the filter after use.



Warning

Avoid particulate and/or gaseous pollutants in the ambient air! The entrainment of pollutants into the ventilator may cause the ventilator to malfunction or cause danger to the patient.

8.4 Preventive Maintenance and Servicing

It is recommended that routine preventive maintenance (PM) and servicing shall be carried out as per the following:

Type	Description	Procedure	Criteria	Schedule	By
PM	Charging battery	User Manual Chapter 8.2	Battery fully charged	Every 6 months	User
PM	Leak test	User Manual Chapter 4.2	No leak observed	Every 6 months	User
PM	Function check	User Manual Chapter 4.2	No abnormal function observed	Every 6 months	User
Servicing	Level II service	Service manual	Meet product specifications	Every 2 years	Manufacturer or authorized service center
Servicing	Full service	Service manual	Meet product specifications	Every 6 years	Manufacturer

Preventive Maintenance

To ensure proper operation of the ventilator, regular inspection and checking of the device and accessories for correct function should be undertaken by a responsible member of staff. It is recommended that a preventive maintenance record be maintained for each unit.

The battery should be charged and the ventilator be checked for leakage and proper function at least every six months, and more frequently in high use applications. Any malfunction unit should be returned to the manufacturer or an authorized service center since this product is not designed for field disassembly or service. Unauthorized repairs will nullify the product warranty.

Level II service

The device shall be returned to the manufacturer or a service center authorized by the manufacturer for bi-annual Level II service every 2 years.

Manufacturer full service

The device shall be returned to O-Two Medical Technologies for Manufacturer Full Service every 6 years.



Warning

Any malfunction unit should be returned to the manufacturer or an authorized service center since this product is not designed for field disassembly or service.

Chapter 9 Technical Data

9.1 Specifications

FEATURES		e600
Device class per MDD		II b
Classification per IEC60601-1	Protection against electric shock	Class II
	Protection against electric shock	Type BF
	Protection against water	IP X4
Power Source		Compressed Oxygen, 45 to 87 PSI (3-6 Bar)
Circuit Control Source		Electric
Ventilation modes		A/C V, SIMV, CPAP, Mask CPR and Intubated CPR
Ventilation Rate		5 - 60 ($\pm 10\%$ or $\pm 1\text{BPM}$)
Minute Volume (L)		Calculated
Tidal Volume (ml)		50 - 2000 \pm (4ml + 15%) BTPS *
Tidal Volume in CPR mode (ml)		50 - 1400 \pm (4ml + 15%) BTPS *
Manually triggered Ventilation		Yes, set flow rate or pressure will be delivered during I time then Inspiratory hold
Maximum Inspiratory hold time		6 sec.
I:E Ratio		1:4 - 3:1 ($\pm 20\%$)
PEEP (cm H ₂ O)		0,4-20 ($\pm 10\%$ or ± 2 cm.H ₂ O)
CPAP (cm H ₂ O)		4-20 ($\pm 10\%$ or ± 2 cm.H ₂ O)
O ₂ (%)		60 or 100 ($\pm 15\%$)
Pmax (cm H ₂ O)		10 - 80 ($\pm 10\%$ or ± 2 cm.H ₂ O)
Pmin (cm H ₂ O)		0 - 20 ($\pm 10\%$ or ± 2 cm.H ₂ O)
Ti (sec.)		0.2 - 9 ($\pm 20\%$)
Trigger sensitivity (L/min)		1 -15, or 2 cm.H ₂ O below baseline in CPAP mode only
APNEA back up time (sec.)		10-60 ($\pm 0.5\text{s}$)
Battery Operating time at room temperature (hrs.)		> 18 hrs for default settings (Data obtained using fully charged new battery)
Altitude compensation		up to 4000m (13000 feet)
Battery Hot Swap		No
Built-in Battery charger		Yes
AC/DC power supply		100-240 VAC/ 19 VDC, 4.74 A
Patient circuit		O-Two Electronic Ventilator Circuit
Mounting Bracket		Mounting brackets for road ambulance and mobile setting
Display		4.3" Color TFT
Live monitoring		Mve, Vte, Paw _(AV) , PAW _(Peak) , Rate (bpm), Battery level
Real time waveform		Pressure or Flow
DAY/NIGHT display mode		Yes

Parameter settings		Control Selection Knob	
Lock key function		Yes	
Pause function		Yes	
Noise level in normal use		Less than 65 dBA	
Alarms (Visual and Audible)			
Gas Supply Pressure		Yes	
Airway Pressure limits		Yes	
Battery status		Yes	
APNEA		Yes	
Breathing Circuit Integrity		Yes	
Leakage		Yes	
Audible silence		Yes, 120 second max	
Dimensions (mm)		250 x 200 x 155	
Weight (Kg)		with Battery w/o Battery	
		2.4 1.77	
Internal Volume of the complete respiratory system (reusable and disposable)		approx. 690 ml without mask approx. 800 ml with mask	
Dead space of patient valve with elbow		Approx. 35 ml	
Compliance (disposable) hose system		16.6 ml/kPa	
Resistance of Patient Hose system (Inhalation and Exhalation):		Less than 6 cmH ₂ O at 60 l/min & Less than 6 cmH ₂ O at 30 l/min	
Environment condition	Ventilator	Operating	- 18°C to +50°C, Rh: 15% to 95%
		Storage	- 40°C to +60°C, Rh: 15% to 95%
	Battery Pack	Charge	0°C to +40°C
		Discharge	- 20°C to +60°C
		Storage	- 20°C to +35°C, low humidity and no corrosive gas atmosphere.
	Patient Circuit	Operating	- 18°C to +50°C, Rh: 15% to 95%
		Storage	- 20°C to +60°C, Rh: 15% to 95%

* BTPS: Volume measurements corrected to Body temperature 37 °C and Barometric pressure 101.3Kpa under saturated conditions (100% Humidity).

Note

Measurement uncertainty: 5% for volume parameters and 6% for pressure parameters.

9.2 Circuit Description

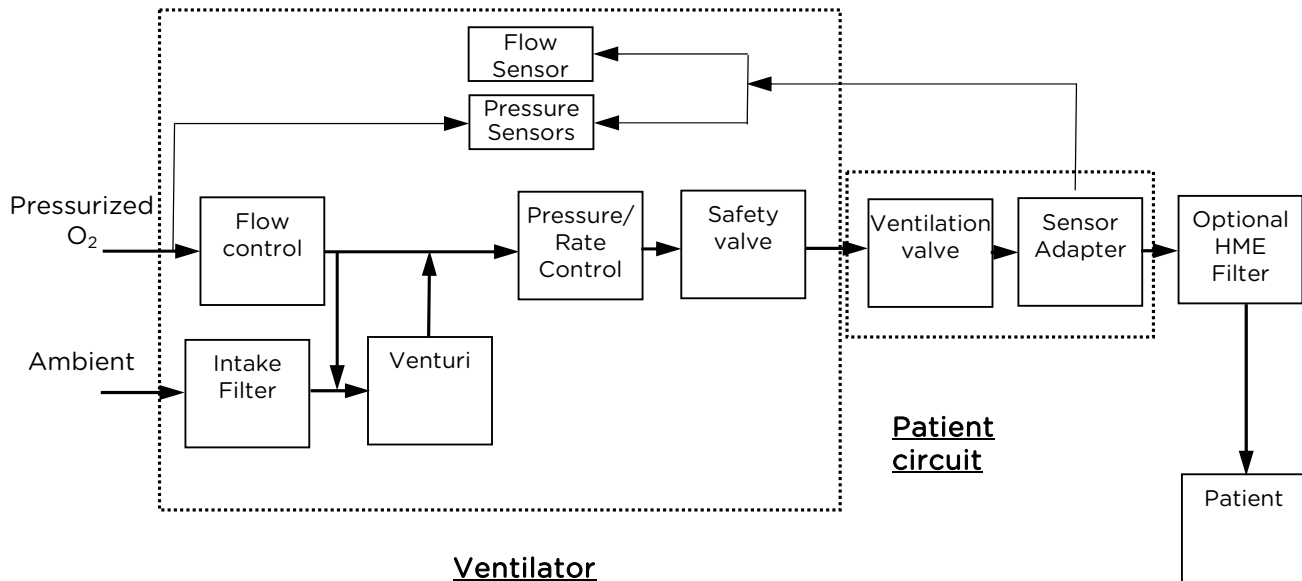

When a gas source (medical oxygen) is supplied to the e600 ventilator via the gas input connection, the gas will flow into the Flow control valve which is used to control both the flow and rate of ventilation. The output of this valve is connected to a selector switch which is used to direct the flow path either directly to the ventilator output (if 100% oxygen ventilation is required) or through a Venturi system used to entrain air to provide an oxygen concentration of 60%.

9.3 Battery & Power Supply

Battery Pack

Battery Cell Type	Rechargeable Lithium Ion Cell
Type	4ICR19/65-3
Nominal Capacity	7500 mAh, Min 111 Wh
Nominal Voltage	14.8 V
Max. Charging Current	3750 mA
Max. Charging Voltage	16.8 V \pm 0.1 V
Dimension	144 x 62 x 42
Weight	642 g
Test specification	Meet requirements of IEC62133:2002

Note

The behaviour of the ventilator will not be affected while the battery is charging.

AC/DC Power Supply

Model	PMP90-13-2 01CV0105
Input Voltage	100 - 240 VAC
Input Current	1.06 - 0.45 A
Input Frequency	47 - 63 Hz
Output Voltage	19 VDC
Output Current	4.74 A Maximum
DC Output Plug	2.5 x 5.5 x 11 mm
DC Output Cable Length	6'
AC Power Cord Length	6'
Weight	642 g
EMC performance	Meet requirements of IEC60601-1-2
Safety Standards	Meet requirements of IEC60601-1:2005

Note

Upon disconnecting AC Power supply, Ventilator will automatically switch to Battery operation without affecting ventilator behaviour.

9.4 Battery Operating Time

Battery operation time ranges from 24 hours in Normal operation and temperature conditions to 15 hours in extreme operation and temperature.

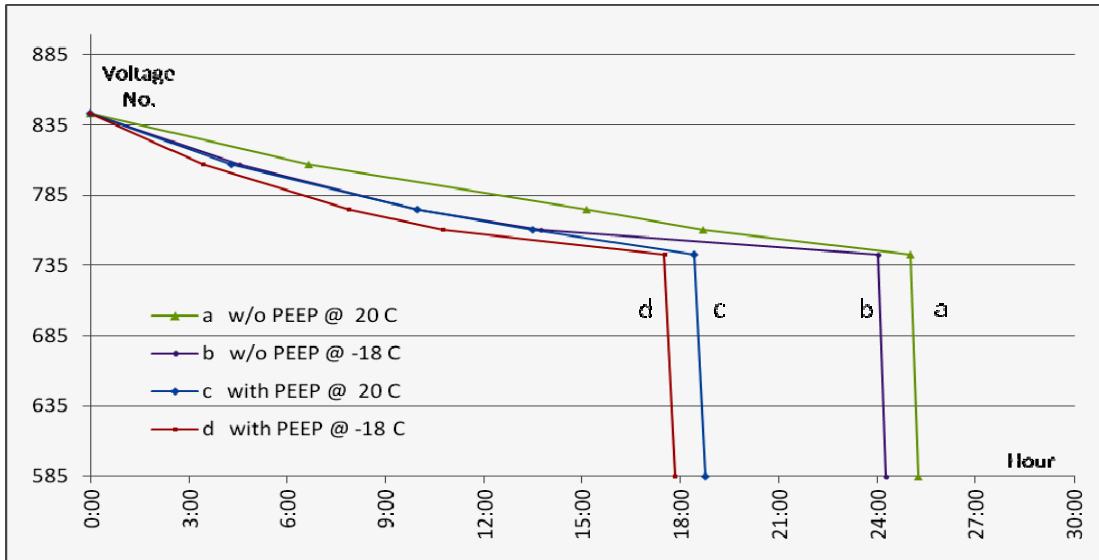

Battery Discharge time

9.5 Electromagnetic Compatibility

O-Two e600 has been tested and complies with IEC 60601-1-2:2007 requirements.

Electromagnetic Emissions

O-Two e600 is intended for use in the electromagnetic environment specified below. The user of **O-Two e600** should assure that it is not used in environments outside those specified:

Emission test	Compliance	Electromagnetic environment - guidance
RF emissions CISPR 11	Group 1	The O-Two e600 uses RF energy only for its internal function. Therefore, its RF emissions are very low and are not likely to cause any interference with nearby electronic equipment
RF emissions CISPR 11	Class B	The O-Two e600 external power supply is suitable for use in all establishments including domestic establishments and those directly connected to the public low-voltage power supply network that supply buildings used for domestic purposes.
Harmonic emissions IEC61000-3-2	Class A	
Voltage fluctuations/ flicker emissions IEC61000-3-3	complies	

Electromagnetic Immunity

Immunity test	IEC60601 required test level	Actual compliance level
Electrostatic discharge (ESD) IEC61000-4-2	± 6 kV contact ± 8 kV air	± 8 kV contact ± 15 kV air
Electrical fast transient/burst IEC61000-4-4	± 2 kV for power supply lines ± 1 kV for input/output lines	± 2 kV for power supply lines ± 1 kV for input/output lines
Surge IEC61000-4-5	± 1 kV line to line; ± 2 kV line to earth	± 1 kV line to line; ± 2 kV line to earth
Voltage dips, short interruptions and voltage variations on power supply input lines IEC61000-4-11	<5%U _T for 0.5 cycle 40%U _T for 5 cycle 70%U _T for 25 cycle <5%U _T for 5 s	<5%U _T for 0.5 cycle 40%U _T for 5 cycle 70%U _T for 25 cycle <5%U _T for 5 s
Power frequency (50/60 Hz) magnetic field IEC61000-4-8	3 A/m	30 A/m
Conducted RF IEC61000-4-6	3Vrms: 50kHz to 80 MHz outside ISM bands	3 Vrms
	10Vrms: 150kHz to 80 MHz in ISM bands	10 Vrms
Radiated RF IEC61000-4-3	10 V/m @ 80 MHz to 2.5 GHz	30 V/m

O-Two e600 is intended for use in the electromagnetic environment in which radiated RF disturbances are controlled. The user can help prevent electromagnetic interference by maintaining a minimum distance between portable and mobile RF communications equipment (transmitters) and the **O-Two e600** as recommended below, according to the maximum output power of the communications equipment:

Rated maximum output power of transmitter W	Separation distance (m)			
	150kHz to 800 MHz outside ISM bands $d = 3.5/\sqrt{3} \cdot \sqrt{P}$	150kHz to 800 MHz in ISM bands $d = 1.2\sqrt{P}$	80 MHz to 800 MHz $d = 1.2\sqrt{P}$	800 MHz to 2.5 GHz $d = 2.3\sqrt{P}$
0.01	0.12	0.12	0.12	0.23
0.1	0.4	0.4	0.4	0.7
1	1.16	1.2	1.2	2.3
10	3.8	3.8	3.8	7.3
100	12	12	12	23

9.6 Oxygen Consumption

For a “D” size cylinder (capacity of 425 liters), pressurized to 2015 PSI and with the e600 set to the Adult default setting ($V_t = 500\text{ml}$, Rate = 10BPM, 100% Oxygen) the pneumatic operating time is 85 minutes without PEEP (0.2 min/L) and is 39 minutes with maximum PEEP (0.089 min/L).

Duration of consumption of a cylinder in minutes is calculated approximately by dividing the liter content by the minute volume with or without PEEP.



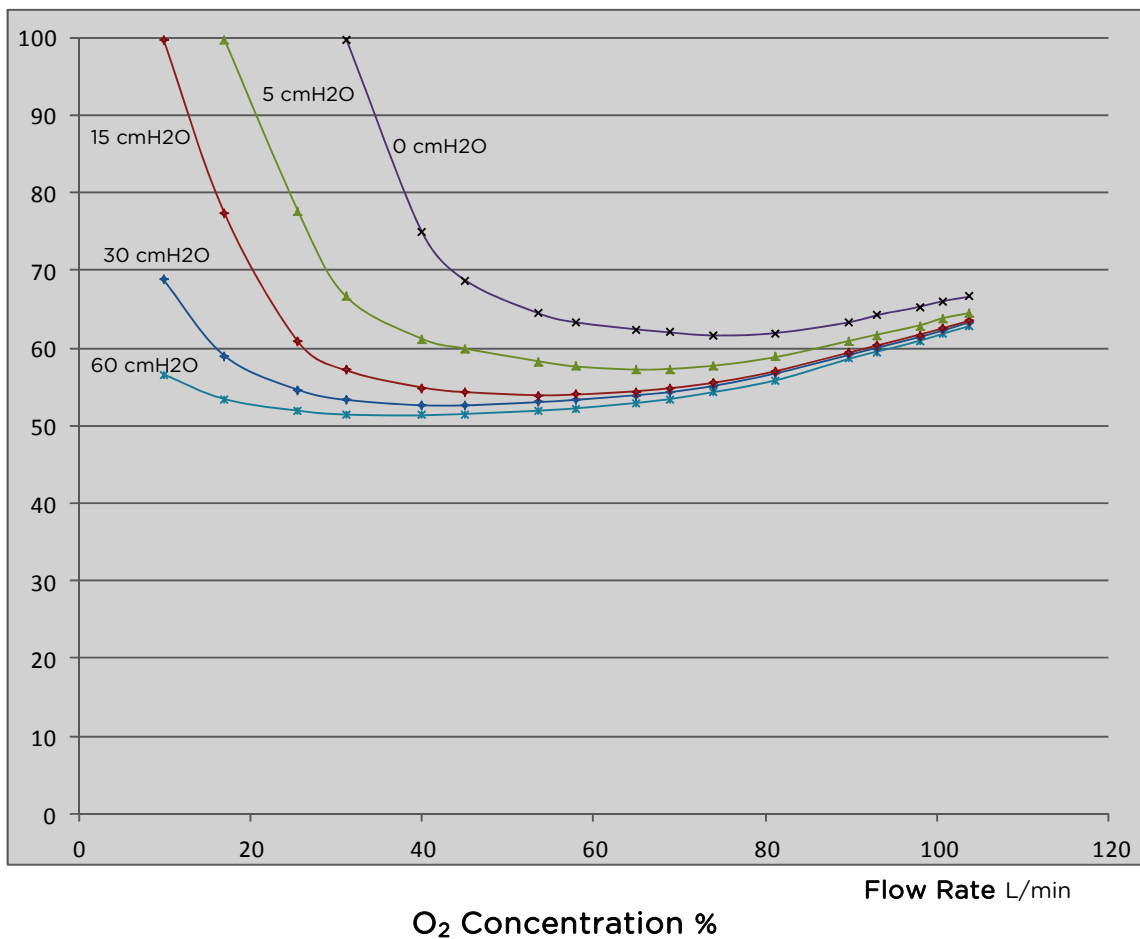

9.7 Oxygen Concentration delivered against different back pressures



Chapter 10 Trouble shooting

Warning

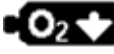
Please contact manufacturer if a problem cannot be rectified. For the safety of the patient and the Health care providers DO NOT continue using the ventilator.

Message/fault	cause	Remedy
 BCI	Leaking mask, ETT, disconnected patient circuit	Make sure mask fits / all patient circuit parts are properly connected./change patient circuit
Low Paw	Low Airway Pressure	Replace hose, check tube position, check ventilation settings and correct
High Paw	High Airway Pressure	Check patient, ventilation circuit, check tube position, adjust Pmax alarm value
 APNEA	Apnea, spontaneous breathing failed or disconnection, faulty sensor	Switch to Assist Control ventilation, ensure connections tight, Replace patient circuit
 O ₂ X	No Oxygen \leq 20 PSI	Change Oxygen cylinder
 O ₂ ↓	Low Oxygen(40-21 PSI)	Change Oxygen cylinder
 LEAK	Leakage, measured expiratory volume is 40% lower than set.	Check leakage in breathing system.
	Invalid setting	Resolve parameters conflict by resetting out of range parameters
Battery discharges quickly	No proper charging/Faulty battery	Charge Battery as per instructions/Replace battery
e600 cannot be switched on	Battery empty/no power supply connected/defective	Change Battery/connect power supply/ send to O-Two for repair or service

Chapter 11 Abbreviations and Acronyms

Term	Explanation
A/C V	Assist Control Ventilation
BCI	Breathing Circuit Integrity (Patient circuit disconnect)
CPAP	Continuous Positive Airway Pressure
CPR	Cardio Pulmonary Resuscitation
Rate	Ventilation rate (number of breaths per minute)
I:E	Ratio of inspiration time to expiration time
LED	Light Emitting Diode
Mve	Exhaled Minute Volume
Mv	Minute volume
O ₂ (%)	Percentage of Oxygen inspired
Paw (AV)	Average airway pressure
Paw (peak)	Peak airway pressure
PEEP	Positive End Expiratory Pressure
P _{max}	Maximum airway pressure
P _{min}	Minimum airway pressure
SIMV	Synchronized Intermittent Mandatory Ventilation
T _{APNEA}	Apnea Alarm time
Te	Expiratory time
TFT	Thin Film Transistor
Ti	Inspiration time
Trig.	Triggering flow rate
Vt _e	Exhaled Tidal volume
Vt	Tidal volume

Chapter 12 Accessories

Item	Part	Order number
1.	O-Two Single-Use Electronic Transport Ventilator circuit 6' (1.83 m)patient circuit	01CV8030
2.	PVC 6' (1.83 m) input pressure hose - 9/16" DISS nut fitting	01FV4302 *
3.	Intake filter-case of 10	01CV8040-cs
4.	Power supply Cord (Canada and the US)	01CV0106 *
5.	Battery Pack	01CV9100
6.	e Ventilator External Power Supply	01CV0105
7.	"SMART MOUNT" Mounting Bracket for Road ambulance	01EV7035
8.	"FIXED MOUNT" Mounting Bracket for mobile setting	01EV7036
9.	1L Test lung	01TA8152
10.	Bacterial and Viral Filter case of 40 / Bacterial and Viral Filter unit. Dead space and Resistance (@ -30 Lpm) of Viral and Bacterial filter: 26 ml & 0.7 cmH ₂ O	02RT7500/U

Note

*When ordering the ventilator please specify the input hose and power cable connectors.

Chapter 13 WARRANTY

O-Two Warrants the e600 ventilator, when used in accordance with the instructions contained within this Manual, for a period of two years from the date of purchase except for the following cases:

1. Using unspecified parts/accessories
2. An attempt to service by unqualified persons/entities
3. Negligence
4. Normal wear and tear (filters, batteries, patient circuits)

Warning

It is recommended that the routine preventive maintenance shall be carried out at least every 6 months from date of purchase. Repair and general overhaul of the ventilator must be carried out by trained service personnel. Evaluation of performance against manufacturer's specifications may be undertaken by suitably qualified personnel to determine if the ventilator is functioning within specification. Any ventilators deemed to be out of specification must be returned to O-Two Medical Technologies Inc. (or one of its approved Service Centers) for service and/or repair.

We recommend that a service contract be obtained with O-Two Medical Technologies Inc. (or one of its approved Service Centers) and that all repairs also be carried out by them.

Only authentic O-Two Medical Technologies Inc. spare parts may be used for maintenance.

Liability for proper function or damage

The liability for the proper function of the apparatus is irrevocably transferred to the owner or operator to the extent that the apparatus is serviced or repaired by personnel not employed or authorized by O-Two Medical Technologies Inc. or if the apparatus is used in a manner not conforming to its intended use.

O-Two Medical Technologies Inc. cannot be held responsible for damage caused by non-compliance with the recommendations given above.

The warranty and liability provisions of the terms of sale and delivery of O-Two Medical Technologies Inc. are likewise not modified by the recommendations given above.

e600

SN _____

O-Two Medical Technologies Inc.
45A, Armthorpe Road, Brampton,
Ontario, Canada, L6T 5M4
Office: +1 905 792 OTWO (6896)
N.A. Toll Free: +1 800 387 3405
Fax: +1 905 799 1339
Email: resuscitation@otwo.com
Web: otwo.com

CE 0120



Marcel Houben
Rue Vinave, 32
4030 LIEGE Belgique